

# DENON

STEREO CD PLAYER

## DCD-1650SR

OPERATING INSTRUCTIONS

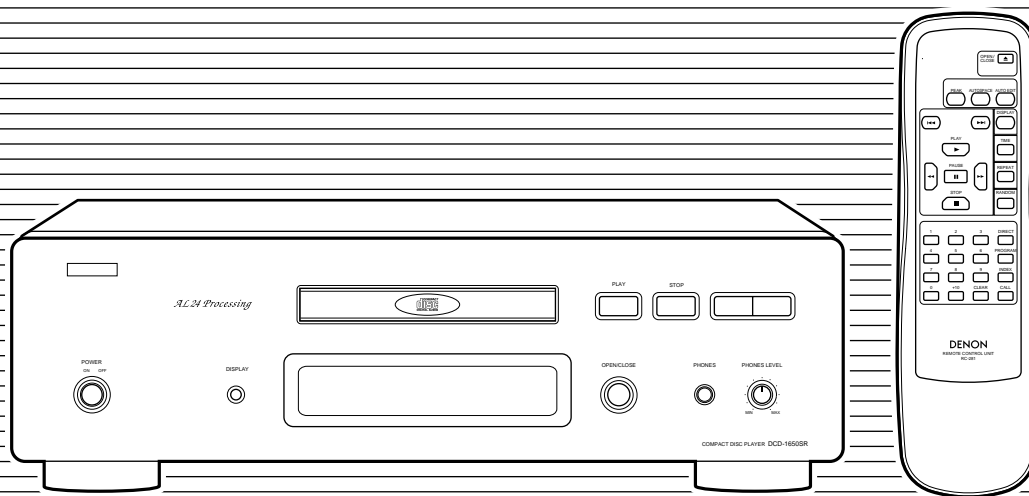

## IMPORTANT TO SAFETY

### WARNING:

TO PREVENT FIRE OR SHOCK HAZARD, DO NOT EXPOSE THIS APPLIANCE TO RAIN OR MOISTURE.

### CAUTION:

1. Handle the power supply cord carefully  
Do not damage or deform the power supply cord. If it is damaged or deformed, it may cause electric shock or malfunction when used. When removing from wall outlet, be sure to remove by holding the plug attachment and not by pulling the cord.
2. Do not open the top cover  
In order to prevent electric shock, do not open the top cover.  
If problems occur, contact your DENON DEALER.
3. Do not place anything inside  
Do not place metal objects or spill liquid inside the CD player.  
Electric shock or malfunction may result.

### NOTE:

This CD player uses the semiconductor laser. To allow you to enjoy music at a stable operation, it is recommended to use this in a room of 5°C (41°F) to 35°C (95°F).

Please, record and retain the Model name and serial number of your set shown on the rating label.

Model No. DCD-1650SR

Serial No. \_\_\_\_\_



**CAUTION**  
RISK OF ELECTRIC SHOCK  
DO NOT OPEN



**CAUTION:** TO REDUCE THE RISK OF ELECTRIC SHOCK, DO NOT REMOVE COVER (OR BACK). NO USER SERVICEABLE PARTS INSIDE. REFER SERVICING TO QUALIFIED SERVICE PERSONNEL.

 The lightning flash with arrowhead symbol, within an equilateral triangle, is intended to alert the user to the presence of uninsulated dangerous voltage within the product's enclosure that may be of sufficient magnitude to constitute a risk of electric shock to persons.

 The exclamation point within an equilateral triangle is intended to alert the user to the presence of important operating and maintenance (servicing) instructions in the literature accompanying the appliance.

### CAUTION:

USE OF CONTROLS OR ADJUSTMENTS OR REFORMATION OF PROCEDURES OTHER THAN THOSE SPECIFIED HEREIN MAY RESULT IN HAZARDOUS RADIATION EXPOSURE.

THE COMPACT DISC PLAYER SHOULD NOT BE ADJUSTED OR REPAIRED BY ANYONE EXCEPT PROPERLY QUALIFIED SERVICE PERSONNEL.

### CLASS 1 LASER PRODUCT

LUOKAN 1 LASERLAITE

KLASS 1 LASERAPPARAT

**ADVARSEL:** USYNLIG LASERSTRÅLING VED ÅBNING, NÅR SIKKERHEDSAFBRYDERE ER UDE AF FUNKTION. UNDGÅ UDSÆTTELSE FOR STRÅLING.

**VAROITUS!** LAITTEEN KÄYTTÄMINEN MUULLA KUIN TÄSSE KÄYTTÄ...OHJEESSA MAINITULLA TAVALLA SAATTA ALTISTAA KÄYTTÄJÄN TURVALLISUUSLUOKAN 1 YLITTEVÄLLE NÄKYMÄTT...MÄLLE LASERSETEILYLLE.

**VARNING-** OM APPARATEN ANVÄNDS PÅ ANNAT SÄTT EN I DENNA BRUKSANVISNING SPECIFICERATS, KAN ANVÄNDAREN UTSÄTTAS FÖR OSYNLIG LASERSTRÅLNING SOM ...VERSKRIDER GRÄNSEN FÖR LASERKLASS 1.

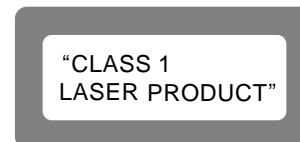

### NOTE:

Use compact discs that include the  mark.

CDs with special shapes (heart-shaped CDs, octagonal CDs etc.) cannot be played on this set.

Attempting to do so may damage the set. Do not use such CDs.

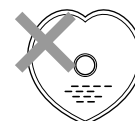



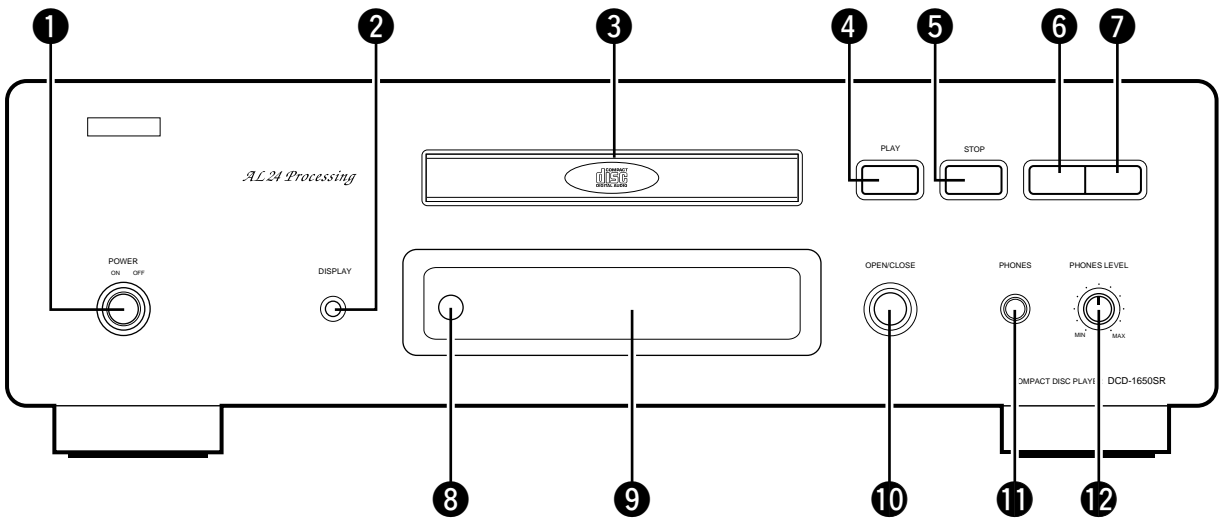

# FRONT PANEL

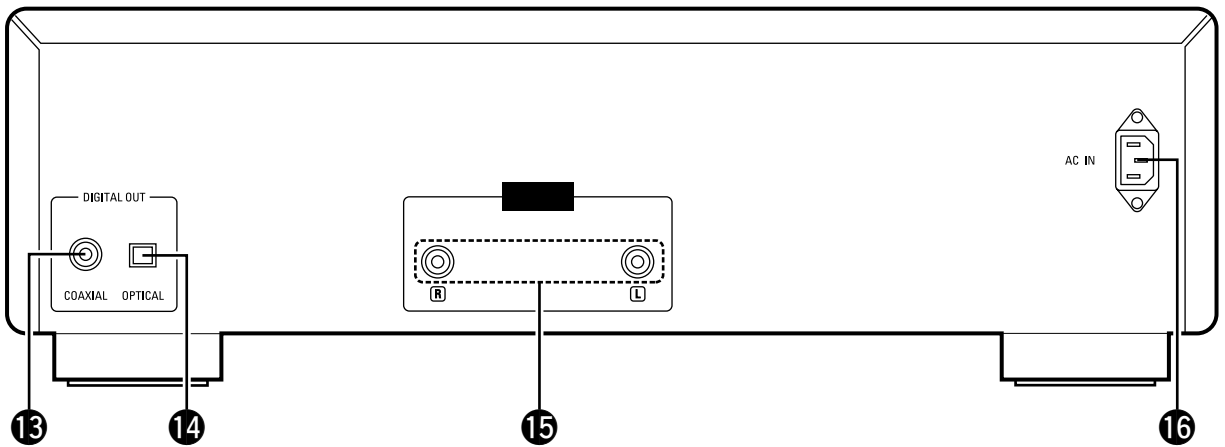

# REAR PANEL

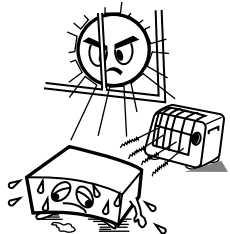
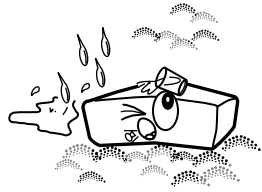
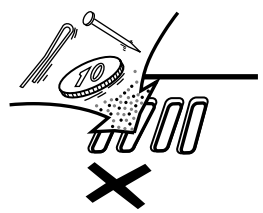
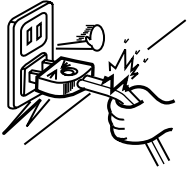
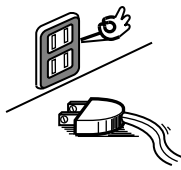

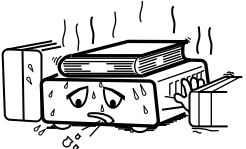
NOTE ON USE

 <p>¥ Avoid high temperatures. Allow for sufficient heat dispersion when installed on a rack.</p>	 <p>¥ Keep the set free from moisture, water, and dust.</p>	 <p>¥ Do not let foreign objects in the set.</p>
 <p>¥ Handle the power cord carefully. Hold the plug when unplugging the cord.</p>	 <p>¥ Unplug the power cord when not using the set for long periods of time.</p>	 <p>¥ Do not let insecticides, benzene, and thinner come in contact with the set.</p>
	 <p>* (For sets with ventilation holes) ¥ Do not obstruct the ventilation holes.</p>	 <p>¥ Never disassemble or modify the set in any way.</p>

Thank you for purchasing this DENON Compact Disc Player. Please read the operating instructions thoroughly in order to acquaint yourself with the CD player and achieve maximum satisfaction from it.

## — TABLE OF CONTENTS —

FEATURES .....	5
NAMES AND FUNCTIONS OF PARTS .....	6
CONNECTION .....	7
OPENING AND CLOSING THE DISC HOLDER AND LOADING A DISC .....	8
NORMAL CD PLAYBACK .....	8
ADVANCED CD PLAYBACK .....	9~13
TIMER-CONTROLLED PLAYBACK .....	13
THE COMPACT DISC .....	13
ABOUT CD-R/RW DISCS .....	13
INSTALLATION PRECAUTIONS .....	13
TROUBLESHOOTING .....	14
PLAYBACK USING THE REMOTE CONTROL UNIT .....	14, 15
SPECIFICATIONS .....	16

**Please check to make sure the following items are included with the main unit in the carton:**

(1) Operating Instructions .....	1
(2) AC Power Cord .....	1
(3) Connection Cord .....	1
(4) Remote Control Unit RC-281 .....	1
(5) R6P AA Dry Cell Battery .....	2

## FEATURES

The DCD-1650SR is the penultimate CD player. It features AL24 Processing developed by DENON to allow analog waveform restoration for a new generation of high-performance media. The player also boasts a Multi 24-Bit D/A Converter system that assures ultimate conversion precision and brings out the full quality potential of AL24 Processing.

### (1) AL24 Processing and Multi 24-Bit D/A Converter

AL24 Processing takes ALPHA Processing technology into a new realm, by reducing quantization distortion even further and allowing perfect analog waveform restoration also for next-generation media with high-bit or high sampling frequency formats. AL24 Processing uses the digital data as a stepping stone, performing sophisticated compensation in order to arrive at a likeness of the analog sound waveform as it existed in the real world. Highly delicate moments such as when music fades into silence or emerges from a quiet background are reproduced with breathtaking fidelity. In order to accurately convert the high quality 24-bit digital data supplied by AL24 Processing, a Multi 24-Bit D/A Converter is used. Operation of this converter is not affected by fluctuations in power supply voltage (current). Furthermore, quantization noise within the passband is uniformly low regardless of frequency, resulting in absolutely transparent, noise-free sound. Two such converters are used per channel and driven in a differential configuration. In conjunction with the  $\lambda$ SLC (Lambda Super Linear Converter) that eliminates zero-cross distortion by principle, this assures impeccable handling even of minute signal levels, for superb sonic clarity.

### (2) Cast Metal Transformer Base and Transformer Case Construction Shuts Out Vibrations

The transformer which can be a source of vibrations is mounted on a cast-metal base with high internal loss, to prevent resonances. The transformer itself is a newly developed type with a cast-metal enclosure designed to suppress internal vibrations that could muddy the sound. The renowned "S.V.H. Loader" principle employs a hybrid construction of plastic and metal to eliminate resonances during play, after a disc has been loaded. Further vibration protection is provided by a coating layer of protein paint and by the double metal guide mechanism that firmly supports the loader on both sides. A dual-layer top cover and triple-layer bottom cover provide high rigidity and protect the player from sound-degrading external vibrations.

### (3) Dual Transformer Design

To preserve sonic purity, the audio circuits and digital circuits are powered by separate transformers. This eliminates the possibility of unwanted interaction between the two sections. The power cord uses an inlet-type design and extra heavy gauge wiring to keep the power supply impedance low.

### (4) CD-RW Playback Capability

The DCD-1650SR can play finalized CD-R and CD-RW discs.

## NAMES AND FUNCTIONS OF PARTS

### 1 Power Operation Button (POWER)

- When the power is turned on, "00" appears at the track number display, and if no disc is loaded, "00000000" appears on the number display and the calendar lights.

### 2 Display Button (DISPLAY)

- Press this button to change the brightness of the display.
- Press once to make the display 2/3 as bright as normal.
- Press again to make the display 1/3 as bright as normal.
- Press once again to turn the entire display off during playback and all but the track number off in any other mode.

### 3 Disc Holder

- This is where the disc is loaded.
- Press the disc holder  $\blacktriangle$  OPEN/CLOSE button 10 to open and close the disc holder.
- The disc holder is also closed if the  $\blacktriangleright$  PLAY button 4.

### 4 Play Button ( $\blacktriangleright$ PLAY)

- Press this button to start playback of a disc.
- When this button is pressed,  $\blacktriangleright$  is displayed, and the track number being played is displayed together with the elapsed playback time of the track.
- Tracks are shown on the calendar display. Once a track has been played, the corresponding track number goes out on the calendar display.

### 5 Stop Button ( $\blacksquare$ STOP)

- Press this button to stop playback.
- The disc will stop rotating, and the number of tracks and total playing time of the disc are displayed on the TRACK NO. and TIME displays, respectively.
- In case programmed playback is engaged when this button is pressed, the number of tracks and total playing time of the program are displayed.

### 6 Automatic Search Reverse Button ( $\blacktriangleleft$ )

- Press this button to return the pickup to the beginning of the present track. Press again to return to other tracks.
- By pressing the button a number of times, the pickup will move back the corresponding number of tracks.

### 7 Automatic Search Forward Button ( $\blacktriangleright$ )

- Press this button to move the pickup forward to the beginning of the next track. Press again to move ahead to other tracks.
- By pressing the button a number of times, the pickup will advance the corresponding number of tracks.

#### Continuous Operation

If the automatic search reverse button 6, the automatic search forward button 7, are held in, the function of that button will be repeated.

### 8 Remote Control Sensor

- This is the sensor for the wireless remote control signals.
- For remote control, point the supplied remote control unit towards this sensor.
- When a signal is transmitted from the remote control unit, the remote control indicator in the display 9 will light up briefly.

### 9 Display Window

- The digital display is divided into sections, such as displays for track number, index, playback time and calendar, as shown below.

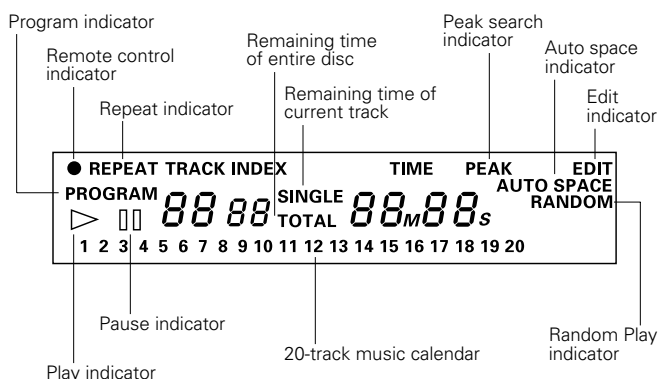

### 10 Disc Holder Open/Close Button ( $\blacktriangle$ OPEN/CLOSE)

- Press this to open and close the disc holder 3.
- When pressed, the disc holder 3 opens. When pressed again, the disc holder 3 closes.
- If a disc is loaded, the total number of tracks on the disc and the total playing time appear on the display window 9 several seconds after the disc holder 3 is closed.

### 11 Headphones Jack (PHONES)

- Use this jack to plug in headphones. (Headphones are sold separately.)

### 12 Volume Adjust Control (PHONES LEVEL)

- Use this to adjust the output level (volume) of the headphones.

### 13 Digital Output Jack (COAXIAL)

- This jack outputs digital data.
- We recommend using a 75  $\Omega$ /ohms pin cord (available in stores) for connections.

### 14 Digital Output Jack (OPTICAL)

- Digital data is output in optical from this jack.
- Contact your nearest DENON Consumer Center or office for information on the optical fiber cable to be used for connection.

### 15 Analog Output Terminal (ANALOG OUT)

- Connect these to the amplifier's input jacks. (Refer to page 7.)

### 16 AC Inlet (AC IN)

- Connect the included AC cord here.

## CONNECTION

### (1) Connections to the Analog Output Jacks

Using the included pin cords, connect the left (L) and right (R) output jacks on the DCD-1650SR to the left (L) and right (R) CD, AUX, or TAPE PLAY input jacks on an amplifier.

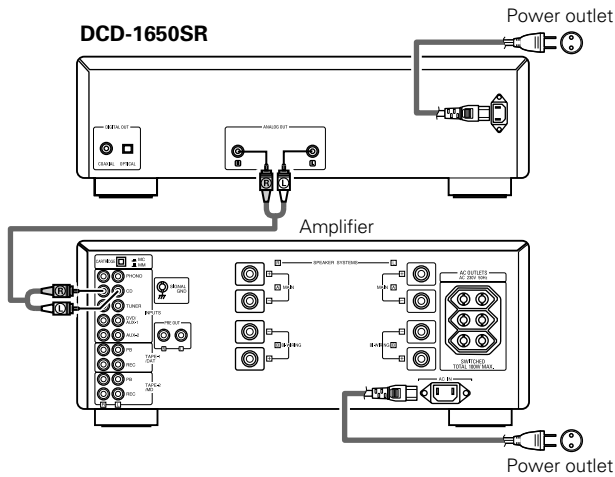

### Connection Precautions

- Before proceeding with connections or disconnections of cables and power cords, be sure to turn all system components off.
- Ensure that all cables are connected properly to the L (left) and R (right) jacks.
- Insert plugs fully into the terminals.
- Connect the output jacks to the amplifier CD, AUX or TAPE PLAY input jacks.
- Making connections with the power turned on may generate noise and could damage the speakers.
- Securely insert the power plug. Incomplete insertion could result in noise.
- Bundling the power cord together with connection cords could result in humming and noise.
- We recommend inserting the power plug in the direction producing the sound quality you prefer.

### (2) Connections to the Digital Optical Output Jack (OPTICAL)

Use an optical fiber cable to connect the digital optical output jack on the DCD-1650SR to the optical input jack on a MD recorder or D/A unit.

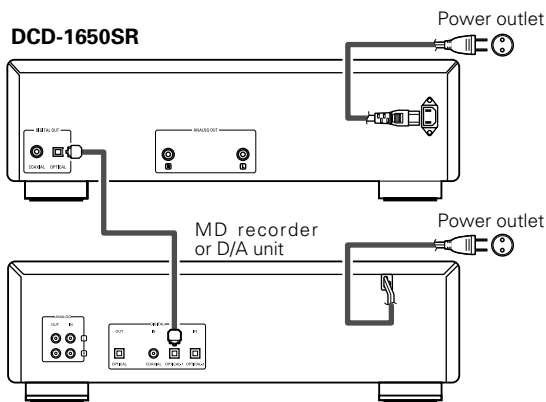

### (3) Connections to the Digital Output Jack (COAXIAL)

Use a 75  $\Omega$ /ohms pin cord to connect the digital output jack (COAXIAL) of the DCD-1650SR to the digital input jack (COAXIAL) on a MD recorder or D/A unit, available in stores.

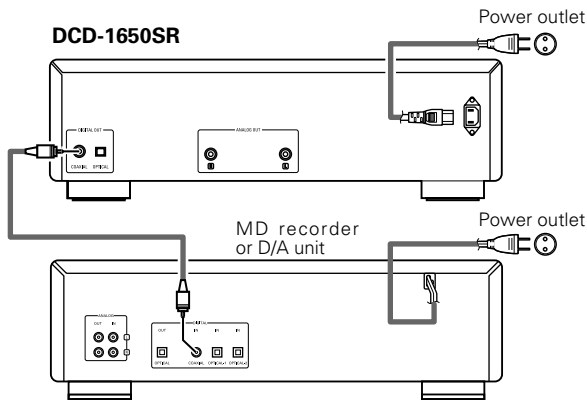

## OPENING AND CLOSING THE DISC HOLDER AND LOADING A DISC

**Opening and closing the disc holder** (This operation only works while the power is on.)

1. Press the power switch (POWER) to turn on the power.
2. Press the ▲ OPEN/CLOSE button.

### How to load a disc

- Make sure the disc holder is completely open.
- Hold the disc by the edges and place it on the disc tray. (Do not touch the signal surface, i.e., the glossy side.)
- When using 12 cm. diameter discs, make sure the outer edge matches the tray guide circumference (Fig. 1), and when using CD singles (8 cm. diameter) match the outer edge with the inner tray guide circumference. (Fig. 2)
- Press the ▲ OPEN/CLOSE button to close the disc holder.
- When the disc holder is closed, the disc is read and after a few seconds the number of tracks and total playing time are displayed on the TRACK NO. and TIME displays, respectively.
- When the disc holder is open and a disc is loaded, you may also press the ► PLAY button to close the disc holder. (If the ► PLAY button is pressed, playback will start immediately upon the disc contents having been read.)

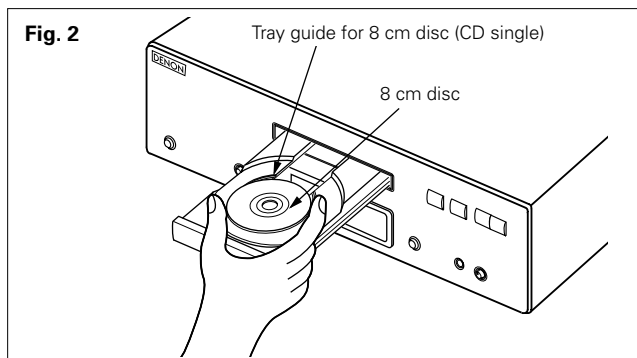
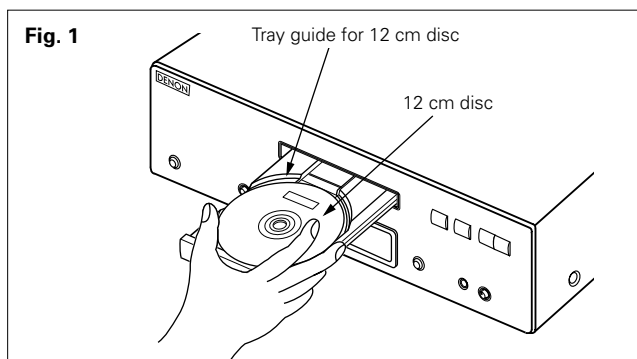

### Caution:

- If your finger should get caught in the disc holder when it closes, press the ▲ OPEN/CLOSE button.
- Do not place any foreign objects on the disc tray, and do not place more than one disc on the tray at a time. Otherwise malfunction may occur.
- Do not push in the disc tray manually when the power is off as this may cause malfunction and damage the CD player.

## NORMAL CD PLAYBACK

### (1) Starting Playback

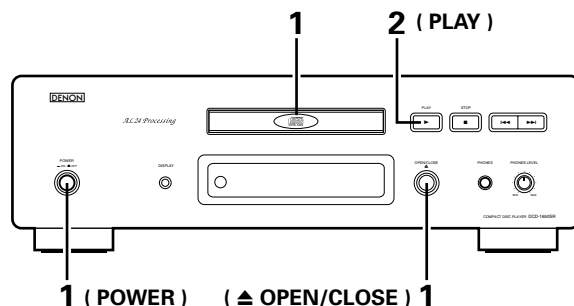

1. Turn the power switch on and load the disc.
2. Press the ► PLAY button.
  - The number of the track currently playing, the index number, and the elapsed time, etc., are displayed.

### (2) Stopping Playback

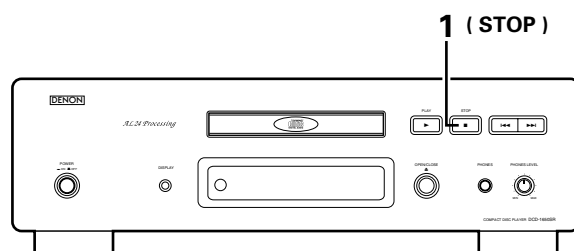

1. Press the ■ STOP button.
  - The stop mode is set automatically once all tracks on the disc are played.

### NOTE:

- If no disc is loaded or if the disc is loaded upside-down, the track number, index, and time displays will all read zero, and the entire calendar will light.



- If the information at the innermost side of the disc cannot be read properly due to dirt or scratches, the display will be as shown below, and the number of tracks and remaining time per track will not be displayed. Also, the search operation may take longer than usual.

When normal



When data cannot be read properly



- Do not use discs on which the glue from cellophane tape or labels has oozed out of the sides of the tape or label, or discs containing traces of peeled off tape or labels. If such discs are loaded in the CD player, they may get stuck and damage the player.



# ADVANCED CD PLAYBACK

## (1) Playing a Specific Track ..... **Direct Search** (Remote control only)

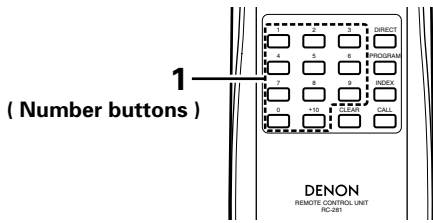

1. Use the number buttons and the +10 button to input the number of the desired track.

- For example, to play the fourth track press [4], and to play the 12th track press [+10] and [2]. The beginning of the track is found and playback starts.

## (2) Moving to Following Tracks During Playback ..... **Automatic Search**

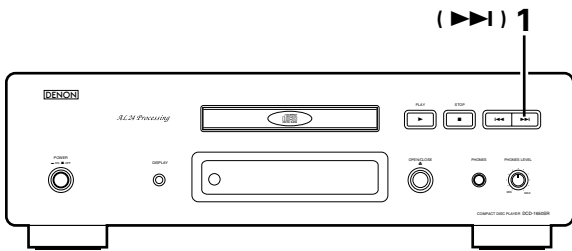

Press the automatic search forward button (▶▶).

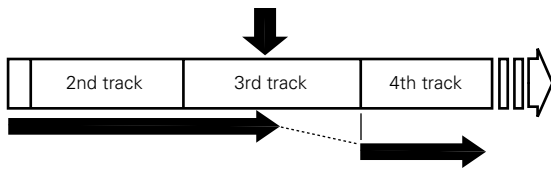

1. Press the automatic search forward button (▶▶)
  - If the automatic search forward button (▶▶) is pressed again during the search operation, the pickup moves on to the next track, etc.

## (3) Returning to the Beginning of the Current Track ..... **Automatic Search**

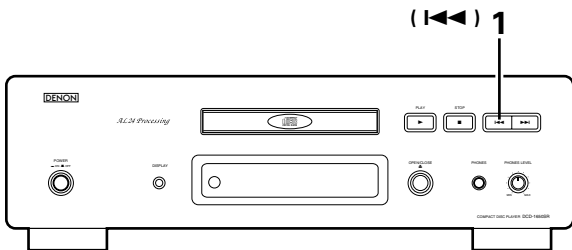

Press the automatic search reverse button (◀◀).

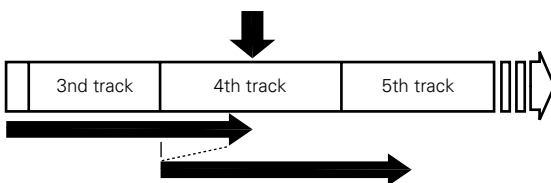

1. Press the automatic search reverse button (◀◀)
  - If the automatic search reverse button (◀◀) is pressed again during the search operation, the pickup moves on to the previous track, etc.

## (4) Finding Sections Within a Track ..... **Index Search** (Remote control only)

- Use this function to start playback from certain sections within a track divided by index numbers.

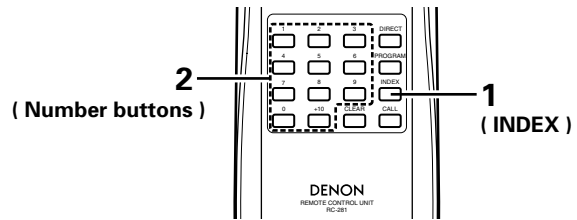

1. Press the INDEX button "..." appears at the TRACK NO. display.
2. Use the number buttons and the +10 button to specify the track number. "..." now appears at the INDEX display. Input the desired index number. Playback starts from there.
  - For example, to start listening from index number 2 on track 3, press [INDEX], [3] and [2].

### Indexes

- Indexes are numbers which are assigned to sections within a track. Check the disc's explanatory notes for the index numbers.
- If you make an index search for an index number that is not on the disc, playback will start from the last index number on the track.

## (5) Playing Specific Tracks in a Specific Order ..... **Programmed Play**

- With this function, you can choose any of the tracks on the disc and program them to play in any order.
- Programming is possible with the disc holder open.
- Up to 20 tracks can be programmed.
- The programmed tracks are shown on the calendar.

### ① Programming (Remote control only)

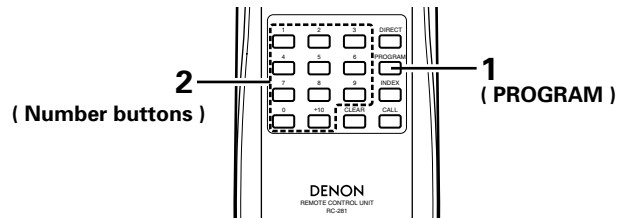

1. The PROGRAM indicator lights when the PROGRAM button is pressed.
2. Press the number buttons and the +10 button to program the tracks.
  - To program tracks 3, 12, and 7, for example, press [PROGRAM], [3], [+10], [2] and [7].
  - The track number lights on the calendar each time a track is programmed. The number of tracks programmed is displayed at the index display, and the total playing time for the programmed tracks is indicated at the time display. After the tracks are programmed, the total number of programmed tracks is displayed at the track number display, and the total playing time for the programmed tracks is indicated at the time display.

② **Checking the Programmed Tracks (Remote control only)**

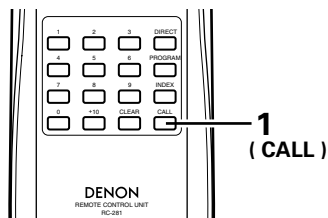

1. Press the CALL button.
  - The programmed tracks are displayed in order on the TRACK NO. display each time the CALL button is pressed.

③ **Playing the Programmed Tracks**

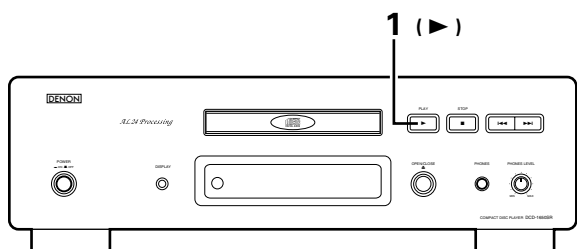

1. Press the ► PLAY button to play the tracks in the programmed order.

④ **Correcting Programs (Remote control only)**

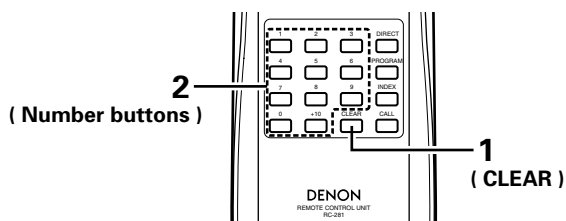

1. To correct a programmed track, first press the CLEAR button.
2. Press the number buttons and the +10 button to program the correct track.
  - The last track programmed is replaced with the correct track.
  - To clear a track in the middle of the program, use the CALL button to call out that track, then press the CLEAR button to clear it from the program.

⑤ **Clearing the Entire Program**

- Press the DIRECT button to clear the entire program. The entire program can also be cleared by pressing the ▲ OPEN/CLOSE button.
- If the DIRECT button is pressed during programmed playback, the program mode is cleared and normal playback continues from that track on.

**NOTES**

- If the programming operation is performed in the play or pause mode, the current track is programmed as the first track in the program. Other programs can be added, but the number of programmed tracks and playing time will not be displayed.
- Direct search is not possible during programmed playback. Pressing the number buttons adds tracks to the end of the program.
- Programming is also possible when the disc holder is open. A track number greater than the number of tracks on the disc can be set in the program, but it will automatically be cleared from the program before playback starts.
- The remaining time per track can only be displayed for the first 20 tracks on the disc.
- The total program time and remaining program time as well will not be displayed if tracks numbers greater than 20 are programmed.

(6) **Play All Tracks Repeatedly ..... Repeat Playback (Remote control only)**

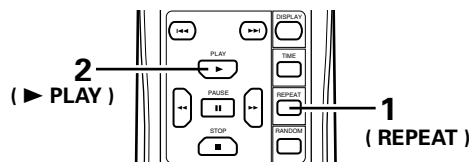

1. Press the REPEAT button. The REPEAT indicator lights.
2. Press the ► PLAY button.
  - The operation is the same whether button 1 or 2 is pressed first.
  - The one-track repeat mode is set if the REPEAT button is pressed again during repeat playback.
  - The all-track repeat mode is set even if the REPEAT button is pressed during playback.
  - To cancel the repeat mode, press the REPEAT button twice.
  - If the REPEAT button is pressed during programmed playback, the tracks are repeated in the programmed order.

(7) **Playing a Single Track Repeatedly ..... One-track Repeat (Remote control only)**

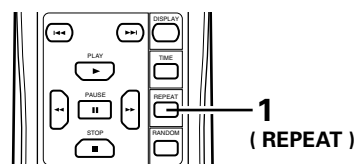

Press the REPEAT button twice.

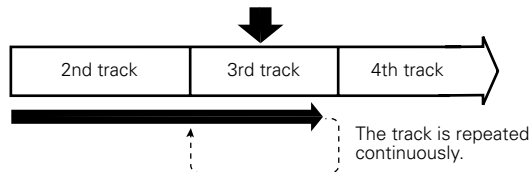

1. Press the REPEAT button twice during playback. The REPEAT indicator lights, and if you are at track number 20 or less, that number appears on the calendar display and that track is played repeatedly.
  - For track numbers 21 and above, the track number is not displayed on the calendar display but the one-track repeat mode will function.
  - If the REPEAT button is pressed twice in the stop mode, track number 1 appears on the calendar display and one-track repeat is possible. Press the ► PLAY button to start playback.
  - Press the REPEAT button once again to cancel the one-track repeat mode. The display and playback return to normal.

**(8) Stopping Momentarily During Playback ..... Pause**  
**(Remote control only)**

- Playback can be stopped momentarily then resumed from the same point.

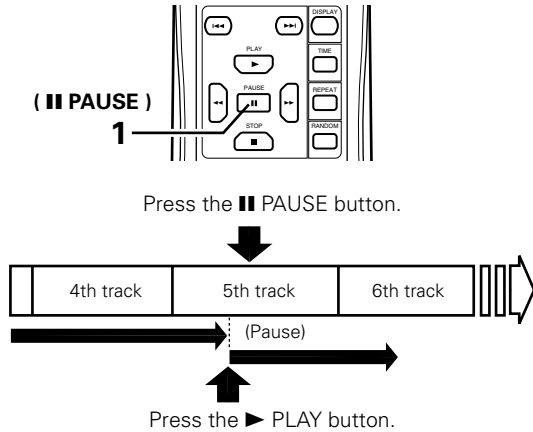

1. Press the **|| PAUSE** button.
  - To resume playback, press either the **▶ PLAY** button or the **|| PAUSE** button.

**(9) Finding a Track While Listening at High Speed ..... Manual Search**  
**(Remote control only)**

- You can skip through the disk while listening at high speed. This function comes in handy for finding a certain part in the middle of a long track and starting playback from there.
- Once you find the desired position using the manual search operation, release the manual search forward button (**▶▶**) or manual search reverse button (**◀◀**) to start normal playback.

**① Manual Search Forward**

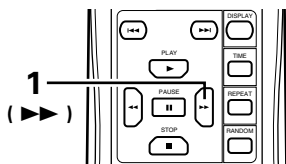

Hold in the manual search forward button (**▶▶**).

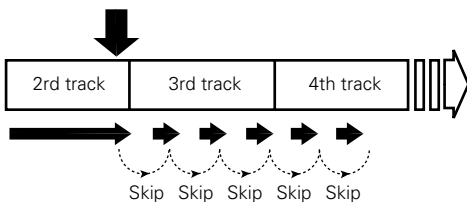

1. During playback, press and hold in the manual search forward button (**▶▶**) to skip through the disc while listening at high speed.
  - The number of the track being skipped through, the index number, and the elapsed time for that track are indicated on the display window.
  - In the pause mode, the disc moves at about three times the speed as during the play mode, but no sound is heard.
  - When the end of the last track is reached while pressing the manual search forward button (**▶▶**), "**]]**" appears on the display window and the manual search operation is stopped. To resume playback, press the manual search reverse button (**◀◀**), then do another operation once the "**]]**" disappears from the display.

**② Manual Search Reverse**

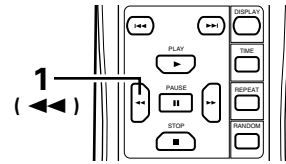

Hold in the manual search reverse button (**◀◀**).

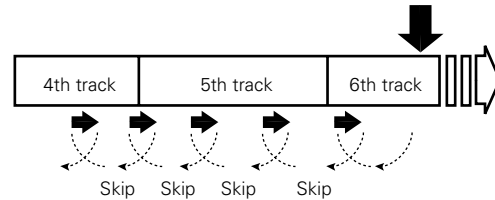

1. During playback, press and hold in the manual search reverse button (**◀◀**) to skip through the disc while listening at high speed.
  - The display is the same as during the manual search forward operation.
  - In the pause mode, the disc moves at about three times the speed as during the play mode, but no sound is heard.
  - When the beginning of the first track is reached while pressing the manual search reverse button (**◀◀**), "**[[**" appears on the display window and the manual search operation is stopped. To resume playback, press the manual search forward button (**▶▶**), then do another operation once the "**[[**" disappears from the display.

**NOTE:**

- The sound may be interrupted momentarily when switching from manual search to normal playback.

**(10) Inserting Blanks Between Tracks ..... Auto Space**  
**(Remote control only)**

- This function inserts blank spaces between tracks, making editing easier.

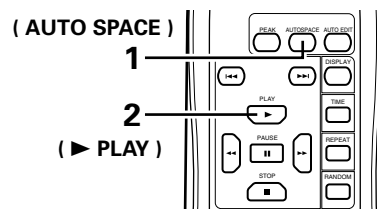

1. The **AUTO SPACE** indicator lights when the **AUTO SPACE** button is pressed.
2. Press the **▶ PLAY** button to start playback. When the end of a track is reached, a blank space of approximately 4 seconds is inserted before the beginning of the next track.
  - Press the **AUTO SPACE** button again to turn the auto space function off.

**(11) Pausing At the Beginning of a Track After Searching ..... Pause (Remote control only)**

**① Direct Search**

- Pausing at the beginning of a track found with the direct search operation comes in handy for practicing karaoke.

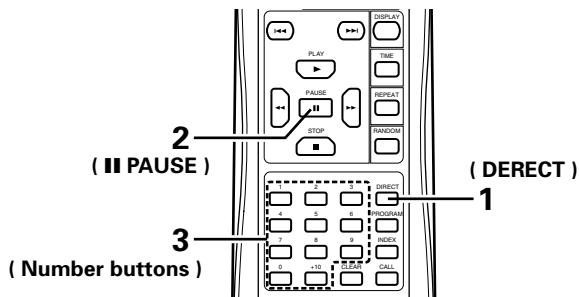

- Press the DIRECT button.
- Press the PAUSE button. To start playback, press either the PLAY button or the PAUSE button
- Use the number buttons to set desired track.

**② Program Search**

- Press the PAUSE button after programming tracks. The beginning of the first track in the program is found and the disc is paused there.

**(12) Playing Tracks in Random Order ..... Random Playback (Remote control only)**

- All of the tracks recorded on the disc can be played once in random order.

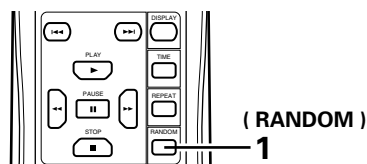

- When the RANDOM button is pressed, the RANDOM indicator lights and RANDOM playback starts automatically.
  - If the random button is pressed when tracks are programmed, only the programmed tracks are played at random.
  - If the RANDOM button is pressed when the repeat function is set, all tracks will be played through once in random order, after which all tracks will be played through again in different order, and so on.
  - During the search operation, the track numbers from the first to the last track on the disc are displayed in rapid succession on the track number display, so you cannot tell what track is going to be played next until playback begins.

**NOTE:**

- The total remaining time is not displayed during the random mode.
- The auto edit mode is cancelled if the RANDOM button is pressed during the auto edit mode.

**(13) Edit Recording on Sides A and B of the Tape ..... Edit Function (Remote control only)**

**Auto Edit Function (AUTO EDIT)**

The auto edit function automatically divides the tracks on the compact disc into sides A and B, with the division at the beginning of a track in such a way that the disc's total playing time is divided as close as possible by one half.

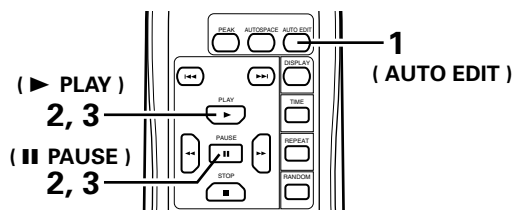

- When the AUTO EDIT button is pressed in the stop condition, the total play time of side A (the first half) and the track numbers (on the calendar) are displayed for about 2 seconds. Next, the side B (last half) information is similarly displayed after which the player automatically pauses at the beginning of the first track of side A. EDIT will be lit on the display at this time.
- Pressing the PLAY button or the PAUSE button will start the play mode. When side A has finished playing, the player will pause at the beginning of the first track on side B.
- Pressing the PLAY button or the PAUSE button again will start the play mode. When side B has finished playing, the player automatically stop.

**NOTE:**

- Auto editing is not possible on discs including 21 tracks or more.
- Direct search is not possible during auto editing.
- The total playing time on the disc is not the same as the total of the track times, so the time displayed in the stop mode (total playing time) may not be the same as the total of the times for sides A and B in the auto edit mode. (There may be a difference of approximately 2 seconds.)

**(14) To Search for the Peak Level of the Disc ..... Peak Search (Remote control only)**

- The player searches for the peak portion and plays a few seconds either side of this point repeatedly. This is convenient for making recording adjustments on the tape recorder.

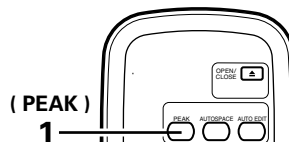

- When the PEAK button is pressed in the stop mode, the PEAK indicator will flash and the player will search for the portion having the peak level.
  - After the search, the PEAK indicator lights up and a few seconds either side of the peak level point are played back repeatedly. This is convenient for making recording adjustments on the tape recorder.
  - To cancel the peak search press the STOP button.
  - When the PLAY button or the PAUSE button is pressed during peak search or while playing the peak portion back repeatedly, the player will go to the beginning of the first track (the first track of the program for program playback) and begin playback from here if the play button was pressed or enter the pause mode if the pause button was pressed.

**NOTE:**

- The peak search function reads the level of the disc from the beginning of the disc to the end at a fixed interval and regards the maximum value that was read as the peak. Peak search takes a little time for this reason.
- The peak portion may change each time the disc is read and there may be a slight difference in the actual peak level, but since this difference is ever so slight there will be no adverse effects on the adjustment of the recording level.
- Buttons other than the ▲ OPEN/CLOSE button, ► PLAY button, ■ PAUSE button, ■ STOP button, and DISPLAY button will not function during peak search or repeat play of the peak portion.

**TIMER-CONTROLLED PLAYBACK**

**■ Operation**

1. Turn on the power of all system components.
2. Set the input selector on the amplifier to correspond to the inputs the CD player is connected to.
3. Make sure a disc has been loaded in the disc holder.
4. Check the time on the timer and then set the desired turn-on time.
5. Turn the audio timer ON.  
Power is turned off automatically in all connected to the timer.
6. When the preset turn-on time is reached, power is turned on in the system components, and CD playback starts from the first track.

**■ Connection**

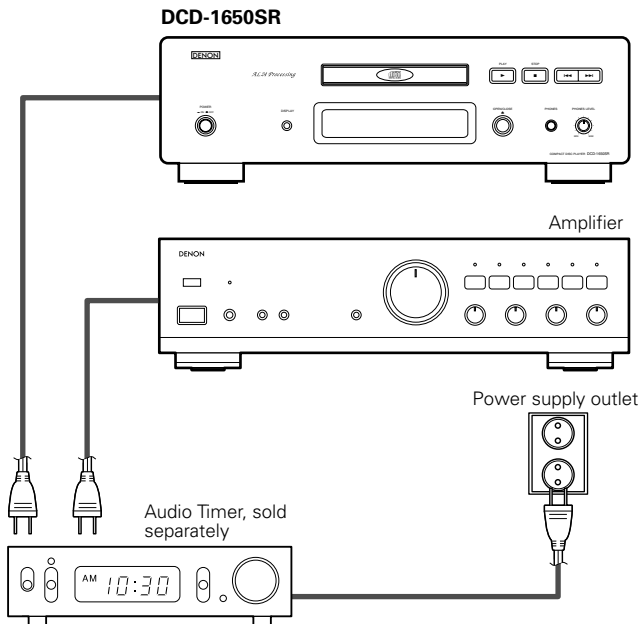

**THE COMPACT DISC**

**1. Precautions on handling compact discs**

- Do not allow fingerprints, oil or dust on the surface of the compact disc.  
If the signal surface is dirty, wipe it off with soft, dry cloth. Wipe in circular motions from the center and out.
- Do not use water, benzene, thinner, record sprays, electrostatic proof chemicals, or silicone-treated cloth to clean discs.
- Always use care when handling discs to prevent damaging the surface, in particular when removing a disc from the case and returning it.
- Do not bend compact discs.
- Do not apply heat to compact discs.
- Do not enlarge the hole in the center of the disc.
- Do not write on the disc and do not attach any labels.
- Condensation will form on the disc surface if it is brought into a warm room from a cold area, such as outdoors during winter. Wait until the condensation disappears. Never dry discs with hair dryers, etc.

**2. Precautions on storage**

- After playing a disc, always return it to its case.
- Keep discs in the cases when they are not to be played. This will protect them from dust and dirt and prolong their service life.
- Do not store discs in the following places:
  - 1) Places exposed to direct sunlight for a considerable time.
  - 2) Places subject to accumulation of dust or high humidity.
  - 3) Places exposed to high temperatures, such as close to heater outlets.

**ABOUT CD-R/RW DISCS**

In some cases, CD-R/RW discs may not be playable, due to scratches or dirt, or to certain recording conditions. Also, discs which have not been finalized cannot be played.

**INSTALLATION PRECAUTIONS**

The CD player uses a microcomputer for controlling internal electronic circuits. In the event that the player is used while a nearby tuner or TV is turned on, although unlikely, interference could occur either in the sound from the tuner or the picture of the TV. To avoid this, please take the following precautions.

- Keep the CD player as far away from the tuner or TV set as possible.
- Keep the power cable and connecting cable of the CD player separate from the antenna wires of the tuner and TV.
- Interference is particularly likely to occur when an indoor antenna or a 300 Ω/ohms feeder cable is used. Thus, use of an outdoor antenna and 75 Ω/ohms coaxial cable is strongly recommended.

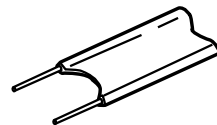

300 Ω/ohms feeder cable



75 Ω/ohms coaxial cable

## TROUBLESHOOTING

If the CD player does not seem to be functioning properly, check the following:

**Disc holder does not open or close.**

- Is the power on?

**When a disc is loaded, 00000000 is displayed.**

- Is the disc loaded properly? .....See page 8
- Is an unrecorded CD-R or CD-RW disc inserted? .....See page 13
- Is a non-finalized CD-R or CD-RW disc inserted?.....See page 13

**When the ► PLAY button is pressed, playback does not start.**

- Is the disc dirty or scratched?.....See page 13

**There is no sound, or it is distorted.**

- Is the output cord properly connected to the amplifier?.....See page 7
- Have the amplifier controls been set correctly?

**A specific section of the disc will not play.**

- Is the disc dirty or scratched?.....See page 13

**Programmed playback does not work.**

- Have programming been properly done? .....See pages 9,10 and 15

**Incorrect operation when buttons on the remote control are pressed.**

- Is the remote control unit being operated too far from the CD player?.....See page 14
- Are there obstacles blocking the ray?
- Is the remote control sensor exposed to strong light?
- Are the batteries exhausted?

## PLAYBACK USING THE REMOTE CONTROL UNIT

The accessory RC-281 remote control unit can be used to control the CD player from a convenient distance.

**(1) Inserting the dry cell batteries**

1. Remove the battery cover on the back of the remote control unit.

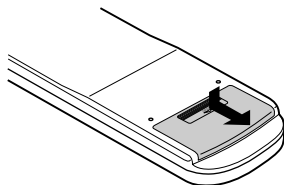

2. Insert two R6P (standard size AA) dry cell batteries with correct polarity as indicated inside battery compartment.

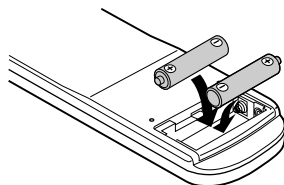

3. Replace the battery cover.

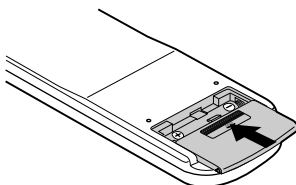

**Notes on the Batteries**

- The remote control unit uses standard size AA dry cell batteries.
- The batteries will need to be replaced approximately once a year. Replacement may be necessary earlier depending on how much the remote control unit is used.
- If, in less than a year from the time new batteries were inserted, the remote control fails to operate the CD player from a near-by position, it is time to replace the batteries.
- The included battery is only for verifying operation. Replace it with a new battery as soon as possible.
- Insert the batteries properly, following the polarity diagram inside the battery compartment, in other words make sure (+) and (-) terminals are properly aligned.

- Batteries are prone to damage and leakage. Therefore:
  - Do not combine new batteries with used ones.
  - Do not combine different types of batteries.
  - Do not jumper opposite poles of the batteries, expose them to heat, break them open nor expose of them in open fire.
  - If the remote control unit is not to be used for a long period of time, remove the batteries from the unit.
  - If the batteries have leaked, remove any traces of battery fluid from the battery compartment, wiping thoroughly with a dry cloth. Then insert new batteries.

**(2) Directions for Use**

- Operate the remote control unit while pointing it towards the remote control sensor on the CD player (see below).

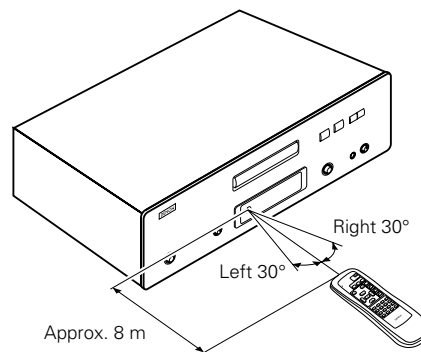

When a remote control signal is received, the remote control indicator on front of the CD player lights briefly.

- The remote control unit can be used at a distance up to 8 meters in a straight line from the CD player. This distance decreases if there are obstructions blocking the signal path or when the remote control unit is operated at an angle from the remote control sensor.
- The buttons on the remote control unit have identical functions with those on the CD player. However, the following functions cannot be remote controlled: Power ON/OFF.

**Cautions on Use**

- Do not press the operation buttons on the main unit and on the remote control unit simultaneously, as this will result in malfunction.
- The remote control unit may not operate properly if the remote control sensor is exposed to direct sunlight or strong artificial lighting, or if there is an object between the remote control unit and the remote control sensor.

# REMOTE CONTROL UNIT RC-281

### Setting to the Program Mode

- For program search, press the PROGRAM button then the number buttons (0 through 9 and +10).
- The remote control unit is normally set to the direct mode.

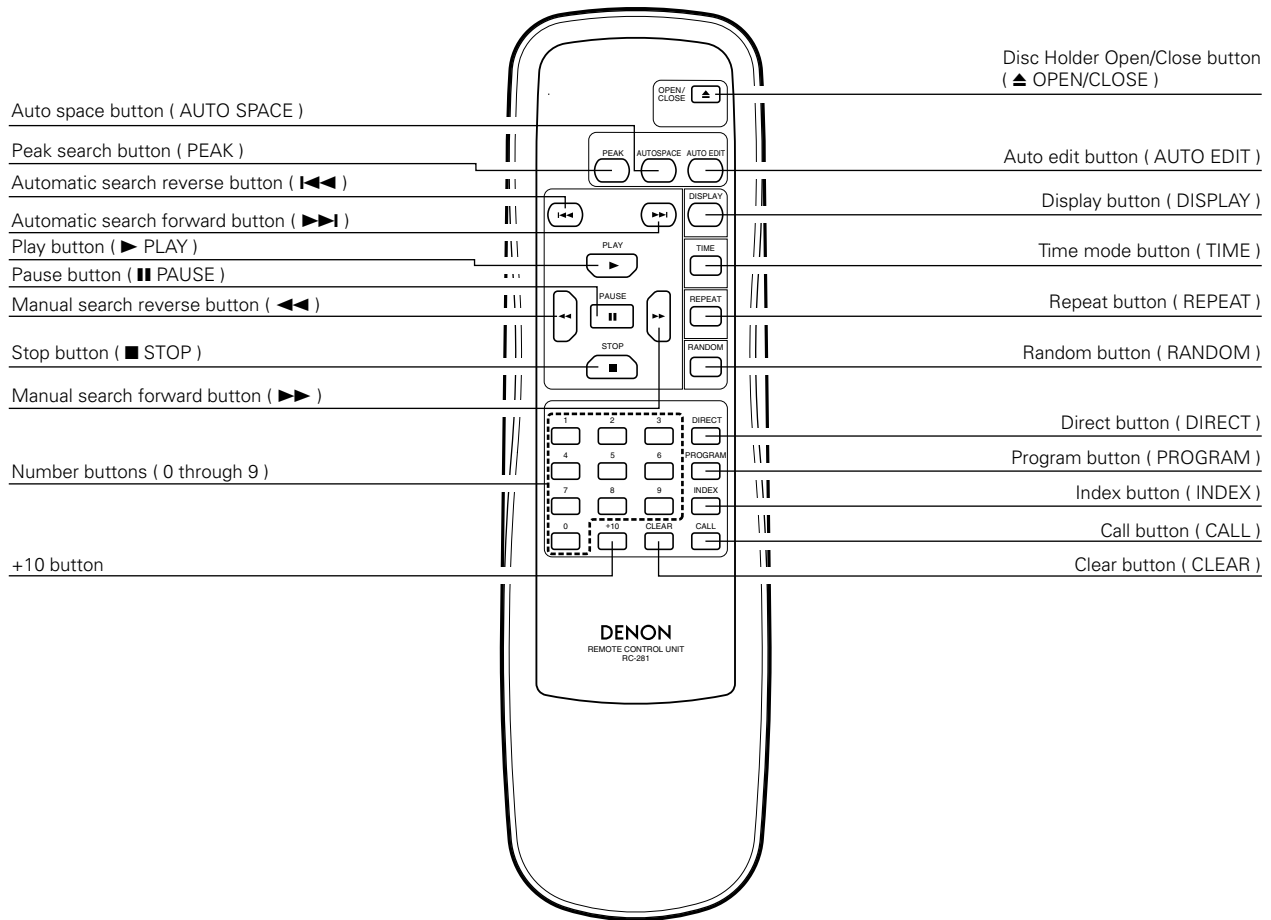

### • Direct Search

Normally, direct search is possible simply by pressing the desired number buttons.

### • Program Search (During playback, the track which is currently playing is programmed as the 1st track.)

Press the PROGRAM button, then press the number buttons.

For example, to program tracks number 3, 11, and 5, press

**PROGRAM** → **3** → **+10** and **1** → **5**.

To cancel the program, press the DIRECT button.

### • Inputting the Track Numbers

For track numbers below 9, simply press the corresponding button. For track numbers of 10 and greater, press the **+10** then the number buttons.

For example, for track number 22 press **+10** twice then **2**.

## SPECIFICATIONS

---

### AUDIO

<b>No. of Channels:</b>	2 channels
<b>Frequency Response:</b>	2 ~ 20,000 Hz
<b>Dynamic Range:</b>	100 dB
<b>Signal-to-noise Ratio:</b>	118 dB
<b>Harmonic Distortion:</b>	0.0018 % (1 kHz)
<b>Separation:</b>	110 dB (1 kHz)
<b>Wow &amp; Flutter:</b>	Below measurable limit: (± 0.001 % W. peak)
<b>Output Voltage:</b>	FIXED 2.0 V

### DISCS

Compact Disc format  
(CD-DA finalized consumer music recording CD-R/RW)

### GENERAL CHARACTERISTICS

<b>Power Supply:</b>	AC 230 V, 50/60 Hz (Asia model) AC 220 V, 50 Hz (China model)
----------------------	--

### Power Consumption:

20 W

### Dimensions:

434 (17-3/32") W x 135 (5-5/16") H x 340 (13-25/64") D mm

### Weight:

12.7 kg (27 lbs 16 oz)

### FUNCTIONS AND DISPLAY

#### Functions:

Direct selection, automatic search, programmed playback, repeat playback, manual search, auto space, time mode, auto edit, index search, peak search.

#### Display:

Track number, time, music, calendar, and engaged modes

#### Others:

Headphones jack

### REMOTE CONTROL UNIT (RC-281)

#### Remote Control System:

Infrared pulse system

#### Power Supply:

3 V DC two R6P (standard size AA) dry cell batteries

#### External Dimensions:

68 (2-43/64") W x 233 (9-11/64") H x 20 (25/32") D mm

#### Weight:

160 g (5.6 oz) (including batteries)

\* Design and specifications are subject to change without notice in the course of product improvement.